



Inter Office Memo

ATTENTION: FOR FINAL ACTION OR MODIFICATION TO OR ADDITION OF CONDITIONS, SEE FINAL BOARD OF SUPERVISORS' ACTION SUMMARY MINUTES

DATE: May 19, 2022
TO: Board of Supervisors
FROM: Planning Commission
SUBJECT: RESOLUTION NO. 12942 - VARIANCE APPLICATION NO. 4125

APPLICANT: Larry King

OWNER: David and Carrie King

REQUEST: Allow for the creation of four substandard sized two-acre lots and a two-acre remainder from an existing 10-acre parcel and waiver of the road frontage requirements. the AL-20 (Limited Agricultural, 20-acre minimum) Zone District.

LOCATION: The project site is located on the northwest corner of 6th Ave. Drive and Mehlert Avenue, adjacent to the City of Kingsburg to the east (APN: 395-030-11) (863 6th Ave. Drive) (Sup. Dist. 4).

PLANNING COMMISSION ACTION:

At its hearing of May 19, 2022, the Commission considered the Staff Report and testimony (summarized in Exhibit A). A motion was made by Vice-Chair Hill and seconded by Commissioner Chatha to determine that all four required variance Findings could not be made. Based on the inability to make the required Findings, a motion was made to deny Variance No. 4125.

This motion was passed on the following vote:

VOTING: Yes: Commissioners Hill, Chatha, Arabian, Ewell, and Zante
No: Commissioner Woolf
Absent: Commissioners Abrahamian and Carver
Abstain: None

RESOLUTION NO. 12942

STEVEN E. WHITE, DIRECTOR
Department of Public Works and Planning
Secretary-Fresno County Planning Commission

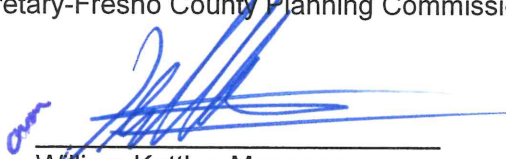
By: 

William Kettler, Manager
Development Services and Capital Projects Division

WMK:er:mp:jp
G:\4360Devs&Pin\PROJSEC\PROJDOCS\VA\4100-4199\4125\Resolution\VA 4125 Resolution.doc

Note:

Attachments

EXHIBIT A

Variance Application No. 4125

- Staff:** The Fresno County Planning Commission considered the Staff Report dated May 19, 2022 and heard a summary presentation by staff.
- Presenters:** The applicant disagreed with the Staff's recommendation and stated the stated variance findings can be made and offered the following information to clarify the intended use:
- The parcel presents an unusual circumstance as it is surrounded by one-acre and two-acre parcels. In addition, the parcel is already substandard in size.
 - Finding No. 2 can be made in part due to the existing parcels surrounding the subject parcel. I wish to conform to similar lot patterns consistent with the surrounding parcels. This constitutes a substantial property right as members from the same zoning classification also have one-acre and two-acre parcels in the vicinity.
 - The proposed project would be in conformance to the General Plan, as the subdivided land will continue to be used for agricultural purposes.
 - We communicated with the neighbors who did not express concerns with the proposal.
- Others:** The son of the Applicant spoke in favor of the application stating the proposed parcels will be used for agricultural purposes (micro farming).
- Two neighbors voiced their opposition to the project. They asserted the newly created parcels would increase both residential density and increase water consumption, further lowering the water table in the area.
- City of Kingsburg:** The City of Kingsburg Community Development Director opposed the project stating current policies for residences to connect to city sewer and water are only to be used in extreme circumstances, of which this project does not qualify. In addition, further subdividing parcels would be inconsistent with the City of Kingsburg's General Plan as this would essentially create residential parcels as opposed to the Plan's intent for agricultural preservation.
- Correspondence:** One letter was distributed to the Planning that expressed opposition to the project stating concerns regarding increased residents and traffic in the area and the negative impact on surrounding properties from additional wells which would further lower the water table.

EXHIBIT "B"

ATTACHMENT
TO
AGENDA ITEM

FISCAL IMPACT STATEMENT

Variance Application No. 4125

Listed below are the fees collected for the land use applications involved in this Agenda Item:

Variance Application:	\$ 6,049.00 ¹
Environmental Review:	259.00 ²
Pre- Application Credit	(247.00) ³
Health Department Review:	<u>365.00⁴</u>
Total Fees Collected	\$ <u>6,460.00</u>

¹ Includes project routing, coordination with reviewing agencies, preparation and incorporation of analysis into Staff Report.
² Review proposal to provide appropriate California Environmental Quality Act (CEQA) evaluation.
³ Pre-Application Credit granted if application filed within 6-month timeframe
⁴ Review of proposal by the Department of Public Health, Environmental Health Division to provide comments.



County of Fresno

DEPARTMENT OF PUBLIC WORKS AND PLANNING
STEVEN E. WHITE, DIRECTOR

Planning Commission Staff Report Agenda Item No. 4 Hearing Date, May 19th, 2022

SUBJECT: Environmental Review No. 8163 and Variance Application No. 4125

Allow for the creation of 4 substandard lots and a remainder and waive road frontage from an existing 10-acre parcel in the AL-20 (Limited Agricultural, 20-acre minimum) Zone District.

LOCATION: The project site is located on the northwest corner of side of 6th Ave Drive and Mehlert Avenue, adjacent to the City of Kingsburg to the east (APN: 395-030-11) (863 6th Ave. Drive) (Sup. Dist. 4)

OWNER: David and Carrie King

APPLICANT: Larry King

STAFF CONTACT: Elliot Racusin, Planner
(559) 600-4245

David Randall, Senior Planner
(559) 600-4052

RECOMMENDATION:

- Deny Variance No. 4125; and
- Direct the Secretary to prepare a Resolution documenting the Commission's action.

EXHIBITS:

1. Conditions of Approval and Project Notes
2. Location Map
3. Existing Zoning Map
4. Existing Land Use Map
5. Site Plans and Detail Drawings
6. Site Elevations

7. Applicant's Operational Statement
8. Applicant's Variance Findings
9. Variance Applications within a Mile-Radius Map

SITE DEVELOPMENT AND OPERATIONAL INFORMATION:

Criteria	Existing	Proposed
General Plan Designation	Agricultural	No change
Zoning	AL-20 (Limited Agricultural, 20-acre minimum)	No change
Parcel Size	10-acres	Parcel 1: 2-acres Parcel 2: 2-acres Parcel 3: 2-acres Parcel 4: 2-acres Remainder Lot: 2-acres
Project Site	Single-family residence with onsite septic system; water well; access off 6 th Ave.	No change
Structural Improvements	None	None
Nearest Residence	54 feet north of the subject parcel	No change
Surrounding Development	Agricultural & single family residential	No change
Nearest Residence	Approximately 59 feet of the north boundary	No change

EXISTING VIOLATION (Y/N) AND NATURE OF VIOLATION: N

ENVIRONMENTAL ANALYSIS:

It has been determined pursuant to Section 15061(b)(3) of the California Environmental Quality Act (CEQA) guidelines, that the proposed project will not have a significant effect on the environment and is not subject to CEQA.

PUBLIC NOTICE:

Notices were sent to 88 property owners within 600 feet of the subject parcel, exceeding the minimum notification requirements prescribed by the California Government Code and County Zoning Ordinance.

PROCEDURAL CONSIDERATIONS:

A Variance may be approved only if four Findings specified in the Fresno County Zoning Ordinance, Section 873-F are made by the Planning Commission.

The decision of the Planning Commission on a VA Application is final, unless appealed to the Board of Supervisors within 15 days of the Commission's action.

BACKGROUND INFORMATION:

The subject parcel is designated Agricultural within the Kingsburg Community Plan and by the City of Kingsburg General Plan.

The Variance was submitted November 16, 2021, proposing to allow the division of the subject 10-acre parcel into four 2-acre parcels with a 2-acre remainder.

There were no relevant variances within one-half mile of the subject parcel regarding reduced size lot and/or waiving road frontage. The only record from 36 years ago of a Variance within the range specified concerned the construction of a mobile home.

The approval of a variance in the vicinity of this project does not create a precedent for approval.

Finding 1: *There are exceptional or extraordinary circumstances or conditions applicable to the property involved which do not apply generally to other property in the vicinity having the identical zoning classification.*

	Current Standard:	Proposed Operation:	Is Standard Met (y/n)
Setbacks	AL-20 (Limited Agricultural, 20-acre minimum parcel size) Front Yard: 35 feet Side Yard: 20 feet Rear Yard: 20 feet	No change	Y
Lot Coverage	No requirement	No change	Y
Space Between Buildings	No requirement	No change	Y
Wall Requirements	No requirement unless pool is present	No change	Y
Septic Replacement Area	100% replacement	No change	Y
Water Well Separation	Septic Tank: 50 feet Disposal Field: 50 feet Seepage Pit: 100 feet	No change	Y

Reviewing Agencies/Department Comments:

No comments specific to the adequacy of the site were expressed by reviewing Agencies or Departments.

Finding 1 Analysis:

In support of Finding 1, the Applicant's states that other variances have been granted in the vicinity of the property and the proposed Variance will allow the existing development pattern and intensity of the subject property to remain.

With regard to Finding 1, records indicate there have been no variance applications within one-half mile of the subject parcel regarding reduced size lot and/or waiving road frontage. While there are parcels in the vicinity under 20 acres, these parcels were created without the need for a variance, either by qualification under Section 816.5-A.2 or because they were created prior to the AE-20 Zoning. The existence of nearby parcels with substandard sizes does not create an exceptional or extraordinary circumstance. Each variance request must be considered on its own merit, based on unique site conditions and circumstances.

The applicant has not shown exceptional or extraordinary circumstances or conditions which do not apply to other parcels under the same zoning classification. All the County parcels in this area having the same zoning and are all subject to the same restriction regardless of size. A 1-acre parcel or a 39-acre parcel both are restricted from dividing their parcel any further, as they will not result in twenty acre or larger parcels.

Recommended Conditions of Approval:

None

Finding 1 Conclusion:

Finding 1 cannot be made as there are not any exceptional or extraordinary circumstances or conditions applicable to the property involved which do not apply generally to other properties in the vicinity.

Finding 2: Such Variance is necessary for the preservation and enjoyment of a substantial property right of the applicant, which right is possessed by other property owners under like conditions in the vicinity having identical zoning classification.

Reviewing Agencies/Department Comments:

No comments specific to the substantial property rights were expressed by reviewing Agencies or Departments.

Finding 2 Analysis:

The applicant asserts the variance is necessary due to the practical difficulties in large scale farming next to residential zoning as well as the surrounding county home sites. Granting the variance would do substantial justice to this property. It would eliminate the undue hardship of not being similar in size to the other "AL" zoned neighboring properties and it would allow this property to be reasonably used in a manner consistent with the existing zoning. In addition, the applicant proposes a road easement to the parcels consisting of a "24-foot-wide roadway plus 4-foot-wide shoulders and 725 feet of length" (See Exhibit 8).

With regard to Finding 2, the Applicant's argument is not relevant, they must demonstrate they are denied a property right which is currently enjoyed by neighboring parcels under the same zoning classification. Their parcel not being as small as other parcels does not deprive the Applicant of any right enjoyed by other property owners in the AL-20 Zone District, since all

property owners are now subject to the same development standards currently imposed and cannot reduce the size of their parcels or create parcels to below the 20-acre minimum.

When General Plan land use designations and zoning are applied to an area that includes substandard sized parcels it is often done to arrest the further division of land into smaller and smaller parcels, otherwise the area of smaller parcels would have been designated for higher densities and zoned like RR or RA allowing one (1) and two (2) acre parcels.

The only exception to the acreage limitation of the Ordinance is if the land was continuously owned by the same parties prior to the adoption of the Zoning Ordinance in 1958, such property owners (not the land) have a preexisting property right that can allow the property to be developed contrary to the parcel size restriction, the right is not transferable to subsequent property owners.

Recommended Conditions of Approval:

If the variance waiving road frontage is approved, all roads and/or access easements must conform to Fresno County Road standards.

Finding 2 Conclusion:

Finding 2 cannot be made as denial of this Variance would not deprive the Applicant of any right enjoyed by other property owners in the AL-20 Zone District, since all property owners are subject to the same development standards and are restricted from reducing or further developing parcels less than 20 acres in size. Granting of the appeal could be construed as granting of a special privilege not enjoyed by surrounding properties with the same zoning.

Finding 3: The granting of a Variance will not be materially detrimental to public welfare or injurious to property and improvement in the vicinity in which the property is located.

Surrounding Parcels

	Size:	Use:	Zoning:	Nearest Residence:
North	1.29-acres	Agricultural	AL-20	100 feet
South	0.3-acres	Agricultural	AL-20	550 feet
East	0.2-acres	Single-family residence	Single Family Residential (City of Kingsburg)	130 feet
West	15-acres	Agricultural	AE-20	1,100 feet

Reviewing Agency/Department Comments:

Environmental Health Division: Future construction projects have the potential to expose nearby residents to elevated noise levels. Consideration should be given to the County of Fresno noise ordinance and the City of Kingsburg municipal codes.

Fresno County Water and Natural Resources Division: The proposal will have a less than significant impact on existing water use (almond orchard). In addition, the subject parcel is not located within an area of the county defined as being a water short area.

No other comments specific to land use compatibility were expressed by reviewing Agencies or Departments.

Finding 3 Analysis:

In reviewing a proposal to create small parcels within agricultural areas, the potential impact on nearby agricultural parcels needs to be considered since any increase in population density in an agricultural area increases the likelihood of conflict with normal farming operations.

Changing the residential density could conflict with the nearby farming operations. However, given its proximity to the city and adjacent smaller parcels, the limited scale of the impacts would not be materially detrimental.

Recommended Conditions of Approval:

None.

Finding 3 Conclusion:

Finding 3 can be made as the granting of a Variance is not materially detrimental to public welfare or injurious to property and improvement in the vicinity in which the property is located due to the project’s limited scope.

Finding 4: *The granting of such a variance will not be contrary to the objectives of the General Plan.*

Relevant Policies:	Consistency/Considerations:
<p>Policy LU-A.6: <i>The County shall maintain twenty (20) acres as the minimum permitted parcel size in areas designated Agriculture, except as provided in Policies LU-A.9, LUA.10 and LU-A.11. The County may require parcel sizes larger than twenty (20) acres based on zoning, local agricultural conditions, and to help ensure the viability of agricultural operations.</i></p>	<p>Inconsistent. See discussion at the Analysis portion of Findings 1 and 2, and further discussion below.</p>
<p>Policy LU-A. 7: <i>The County shall generally deny requests to create parcels less than the minimum size specified in Policy LU-A.6 based on concerns that these parcels are less viable economic farming units, and that the resultant increase in residential density increases the potential for conflict with normal agricultural practices on adjacent parcels. Evidence that the affected parcel may be an uneconomic farming unit due to its current size, soil conditions, or other factors shall not alone be considered a</i></p>	<p>Inconsistent. See discussion below.</p>

Relevant Policies:	Consistency/Considerations:
<i>sufficient basis to grant an exception. The decision-making body shall consider the negative incremental and cumulative effects such land divisions have on the agricultural community.</i>	
Policy PF-C.17: <i>The County shall, prior to consideration of any discretionary project related to land use, undertake a water supply evaluation.</i>	Consistent. Review of this project by the Water/Geology/Natural Resources Section determined that there were no water concerns related to this application.
Policy LU-A.14: <i>The County shall ensure that the review of discretionary projects includes an assessment of the conversion of productive agricultural land and that mitigation be required where appropriate.</i>	Consistent. Review of this project by the Agricultural Commissioner determined no issues with the proposed parcel as the subject parcel is adjacent to the city as well as a significant number of existing residential parcels and continuing to farm the parcel would be difficult due to Ag/urban interface issues.
Policy LU-A: <i>To promote the long-term conservation of productive and potentially-productive agricultural lands and to accommodate agricultural-support services and agriculturally-related activities that support the viability of agriculture and further the County's economic development goals.</i>	Inconsistent: Both the County and the City of Kingsburg have a Right to Farm Ordinance which are intended to preserve agricultural lands.

Reviewing Agency Comments:

Policy Planning Section of the Fresno County Department of Public Works and Planning: Regarding Policies LU-A.6 and LU-A.7: The County General Plan recognizes 20 acres as the minimum parcel size for agricultural uses. The County generally denies requests to create lots smaller than 20 acres in areas primarily designated for Agriculture to maintain land as economic farming units and reduce the conflicts from incompatible uses on the local agricultural community.

The five 2-acre (gross) parcels proposed are similar in size to the 2-acre minimum parcel sizes found in areas designated as Rural Residential in the County. Therefore, the proposed Variance does not appear to be consistent with these policies as the proposed variance application will result in creation of homesite lots.

City of Kingsburg: Our City policy requires parcels in the City limits to be connected to water and sewer services. Exceptions to this for parcels outside the City Limits can be made with an Out of Agency Service Agreement when physically possible, often when an existing water source (a well) has failed. There is a process of review and approval for that. This request does not fall under the requirements for that consideration. Ideally, the provision of services (water, sewer) is part of a larger annexation action, which would require connections to City water and to SKF Sanitation District.

Additionally, the City of Kingsburg feels that the findings for a variance cannot be made for this project. Their rationale for hardship is that it is becoming difficult to farm in close proximity to

Kingsburg. Both the County and the City of Kingsburg have a Right to Farm Ordinance which should protect their current land use.

No other comments specific to General Plan Policy were expressed by reviewing Agencies or Departments.

Finding 4 Analysis:

The Applicant states that the purpose of the 20-acre minimum lot size is to prohibit the creation of parcels that cannot effectively produce an agricultural product. The proposed Variance seeks to memorialize the ownership wishes of the Applicant’s family and maintain the development pattern and intensity of the subject parcel.

The operational statement describes the purpose of the proposed project as for “micro-farming and agricultural use” for the purpose of creating “more manageable ranching activities on a micro-farm level.”

Policy LU-A is intended to promote the long-term conservation and preservation of agricultural land. Further division of the land undermines the Goal of Agricultural preservation.

Policy LU-A.6 The County shall maintain twenty (20) acres as the minimum permitted parcel size in areas designated Agriculture, except as provided in Policies LU-A.9 (Home Sites), LU-A.10 (AG Commercial), and LU-A.11 (Mineral Extraction). The application does not meet the provisions of the allowed exceptions.

Policy LU-A.7 states the County shall generally deny requests to create parcels less than the minimum size specified in based on concerns that these parcels are less viable economic farming units and warns that the resultant increase in residential density increases the potential for conflict with normal agricultural practices.

Policy LU-A.14 was reviewed by the Agricultural Commissioner who stated continuing to farm the parcel would be difficult due to Ag/urban interface issues. It was ultimately determined there were no issues with the proposed parcel as the close proximity to the city as well as a significant number of existing residential parcels prevent productive agricultural cultivation.

Recommended Conditions of Approval:

None.

Finding 4 Conclusion:

Finding 4 cannot be made based on the analysis above. The application is inconsistent with General Plan Goal LU-A and Policy LU-A.6 and LU-A-7.

PUBLIC COMMENT:

No public comment was received as of the date of preparation of this report.

SUMMARY CONCLUSION:

The existence of other small parcels in the area is not a basis for granting a variance. Granting of the variance could be construed as inconsistent with Government code section 65906 which prohibits granting of unqualified variances and states in part "...shall constitute a grant of special privileges inconsistent with the limitations upon other properties in the vicinity and zone in which such property is situated." There are no provisions in the ordinance to create substandard parcels when you no longer wish to continue agricultural activities.

Based on the factors cited in the analysis, the required Findings for granting the Variance Application cannot be made:

- There are no exceptional or extraordinary circumstances or conditions applicable to the property,
- The variance is not necessary for the preservation and enjoyment of a substantial property right of the applicant, which right is possessed by other property owners under like conditions in the vicinity, and
- The application is contrary to the goals and policies of the General Plan.

PLANNING COMMISSION MOTIONS:

Recommended Motion (Denial Action)

- Move to determine that required Findings 1, 2, & 4 cannot be made as stipulated by the staff report and move to deny Variance Application No. 4125; and
- Direct the Secretary to prepare a Resolution documenting the Commission's action.

Alternative Motion (Approval Action)

- Move to determine the required Findings can be made (state basis for making the Findings) and move to approve Variance Application No. 4125, subject to the Mitigation Measures, Conditions of Approval and Project Notes listed in Exhibit 1; and
- Direct the Secretary to prepare a Resolution documenting the Commission's action.

Recommended Conditions of Approval and Project Notes:

See attached Exhibit 1.

ER:jp
G:\4360Devs&PIn\PROJSEC\PROJDOCS\VA\4100-4199\4125\Staff Reports\VA 4125 SR.docx

EXHIBIT 1

**Mitigation Monitoring and Reporting Program
 Variance Application No. 4125 & Environmental Review No. 8163
 (Including Conditions of Approval and Project Notes)**

Conditions of Approval	
1.	Development shall be in accordance with the site plan as approved by the Planning Commission.
2.	If the variance waiving road frontage is approved, all roads and/or access easements must conform to Fresno County Road standards.

Notes	
The following Notes reference mandatory requirements of Fresno County or other Agencies and are provided as information to the project Applicant.	
1.	An encroachment permit is needed from the Road Maintenance and Operations Division for any work done within the road right-of-way of County of Fresno.
2.	Future construction projects have the potential to expose nearby residents to elevated noise levels. Consideration should be given to the County of Fresno noise ordinance and the City of Kingsburg municipal codes.
3.	At such time the applicant or property owner(s) decides to construct a new water well, the water well contractor selected by the applicant will be required to apply for and obtain a Permit to Construct a Water Well from the Fresno County Department of Community Health, Environmental Health Division. Please be advised that only those persons with a valid C-57 contractor's license may construct wells. For more information, contact the Water Surveillance Program at (559) 600-3357.
4.	As a measure to protect ground water, all water wells and/or septic systems that exist or have been abandoned within the project area should be properly destroyed by an appropriately licensed contractor.
5.	Should any underground storage tank(s) be found, the applicant shall apply for and secure an Underground Storage Tank Removal Permit from the Fresno County Department of Public Health, Environmental Health Division. Contact the Fresno County Hazmat Compliance Program at (559) 600-3271 for more information.
6.	All new sewage disposal systems that are proposed, shall be installed under permit and inspection by the Department of Public Works and Planning Building and Safety Section. Contact Department of Public Works and Planning at (559) 600- 4540 for more information.
7.	According to FEMA FIRM Panel 2675H, the parcel is not subject to flooding from the 100- year storm
8.	The subject property is within the City of Kingsburg SOI (Sphere of Influence). Any future off-site improvements and driveway placement relative to the property line should be consulted with the City regarding their requirements.
9.	Any existing or future access driveway should be set back a minimum of 10 feet from the property line.

Notes	
10.	Any existing or future entrance gate should be set back a minimum of 20 feet from the road right-of-way line or the length of the longest truck entering the site and shall not swing outward.
11.	A 10 foot x 10 foot corner cut-off should be improved for sight distance purposes at any future or existing driveway accessing Sixth Avenue Drive if not already present.
12.	Any future work done within the County road right-of-way to construct a new driveway or improve an existing driveway will require an Encroachment Permit from the Road Maintenance and Operations Division.
13.	If the variance is approved, a parcel map application will have to be filed with Fresno County to affect the property division. Furthermore, if there is no legal access provided to any proposed parcel without public frontage access, a covenant is required, whereby the Subdivider agrees to grant a 60' wide access easement to each parcel as it is created. A Registered Civil Engineer shall certify the access easements are improved to a condition to meet the needs of the users. And any future grading, including onsite grading, will require either an engineered grading and drainage plan, road improvement plan, permit, or voucher.
14.	Any new development of less than two acres or secondary dwelling will require a nitrogen loading analysis by a qualified professional, demonstrating to the Department of Public Works and Planning (Department) that the regional characteristics are such that an exception to the septic system density limit can be accommodated. The Department will refer any analysis to the Regional Water Quality Control Board, Central Valley Region for their concurrence and input.
15.	It is the recommendation of the County Surveyor's Office that this application be denied, unless 1) the limits of the Subdivision and the Designated Remainder can be clearly shown on the application, and 2) any improvements (access easement/roadway cul-de-sac) for the purposes of the Subdivision lie wholly within the limits of the Subdivision.

LOCATION MAP

VA 4125

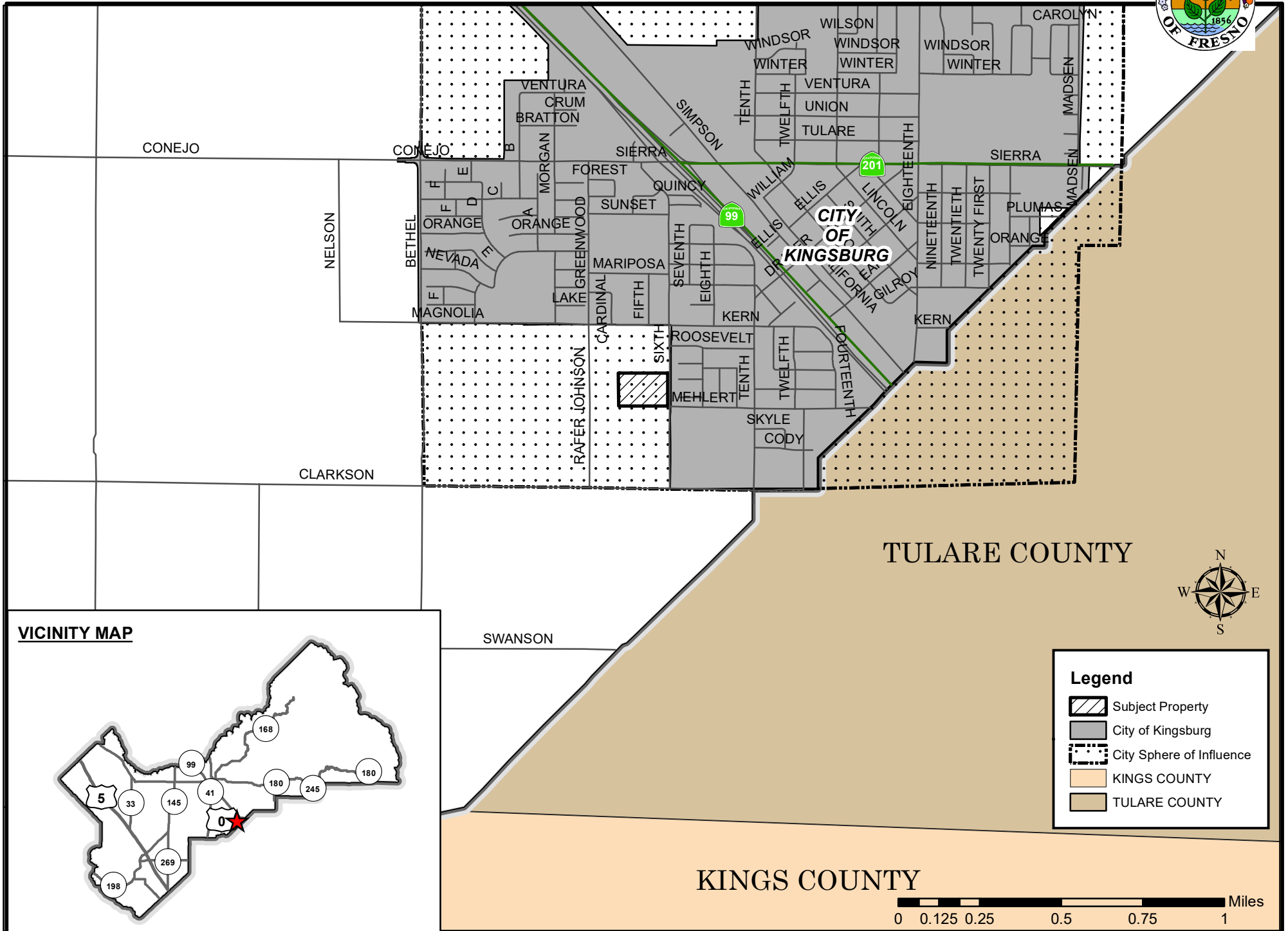
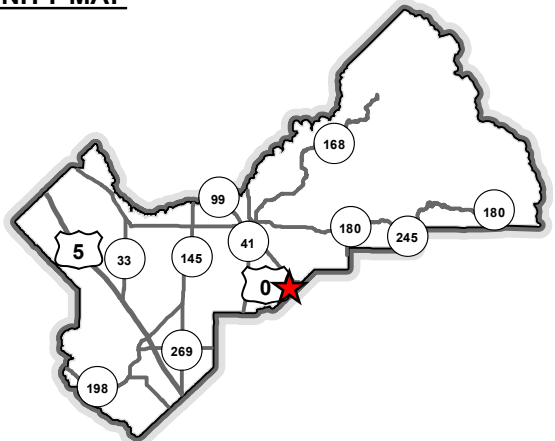

EXHIBIT 2

VICINITY MAP



Legend

- Subject Property
- City of Kingsburg
- City Sphere of Influence
- KINGS COUNTY
- TULARE COUNTY

EXHIBIT 3
EXISTING ZONING MAP

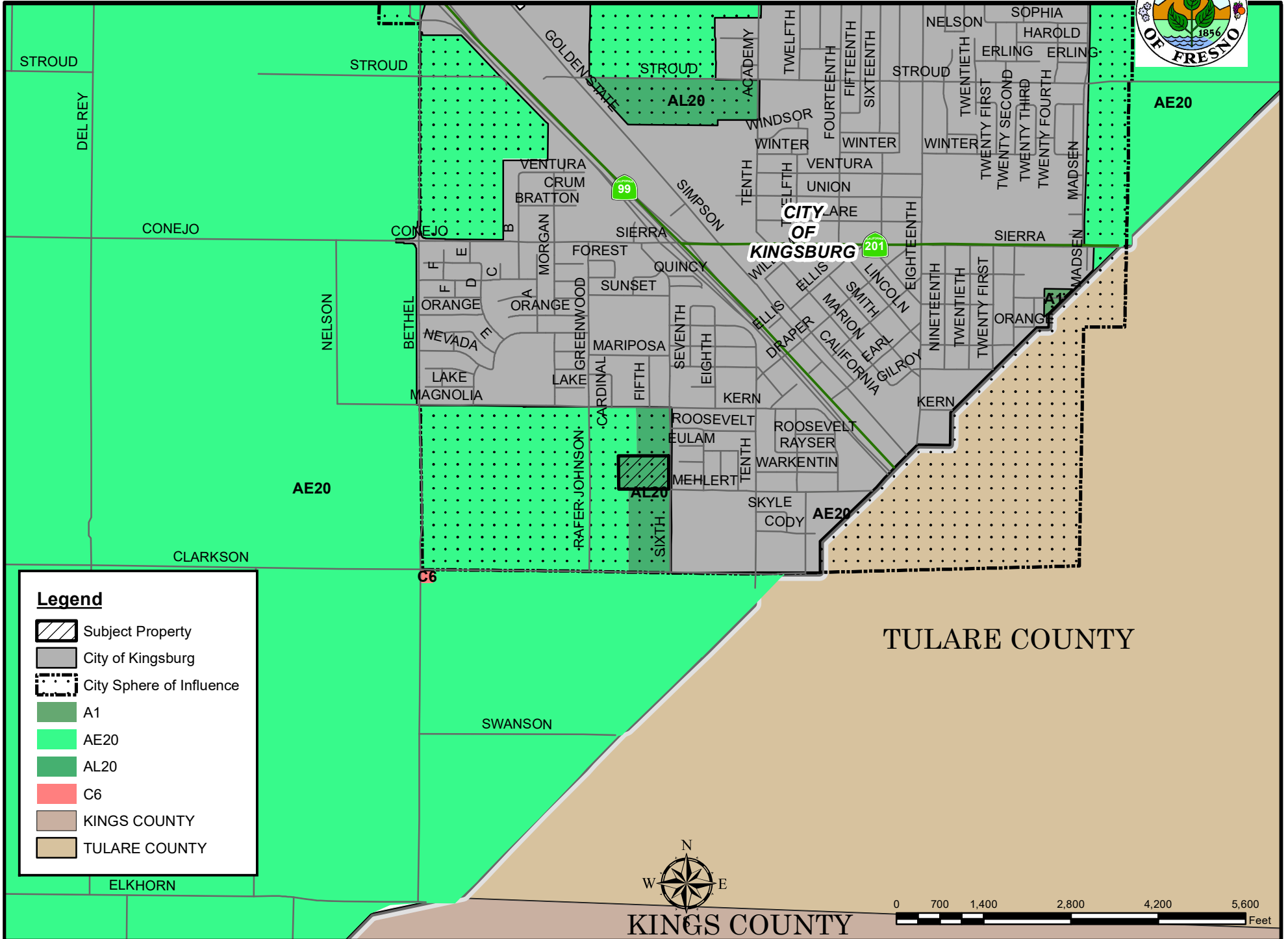
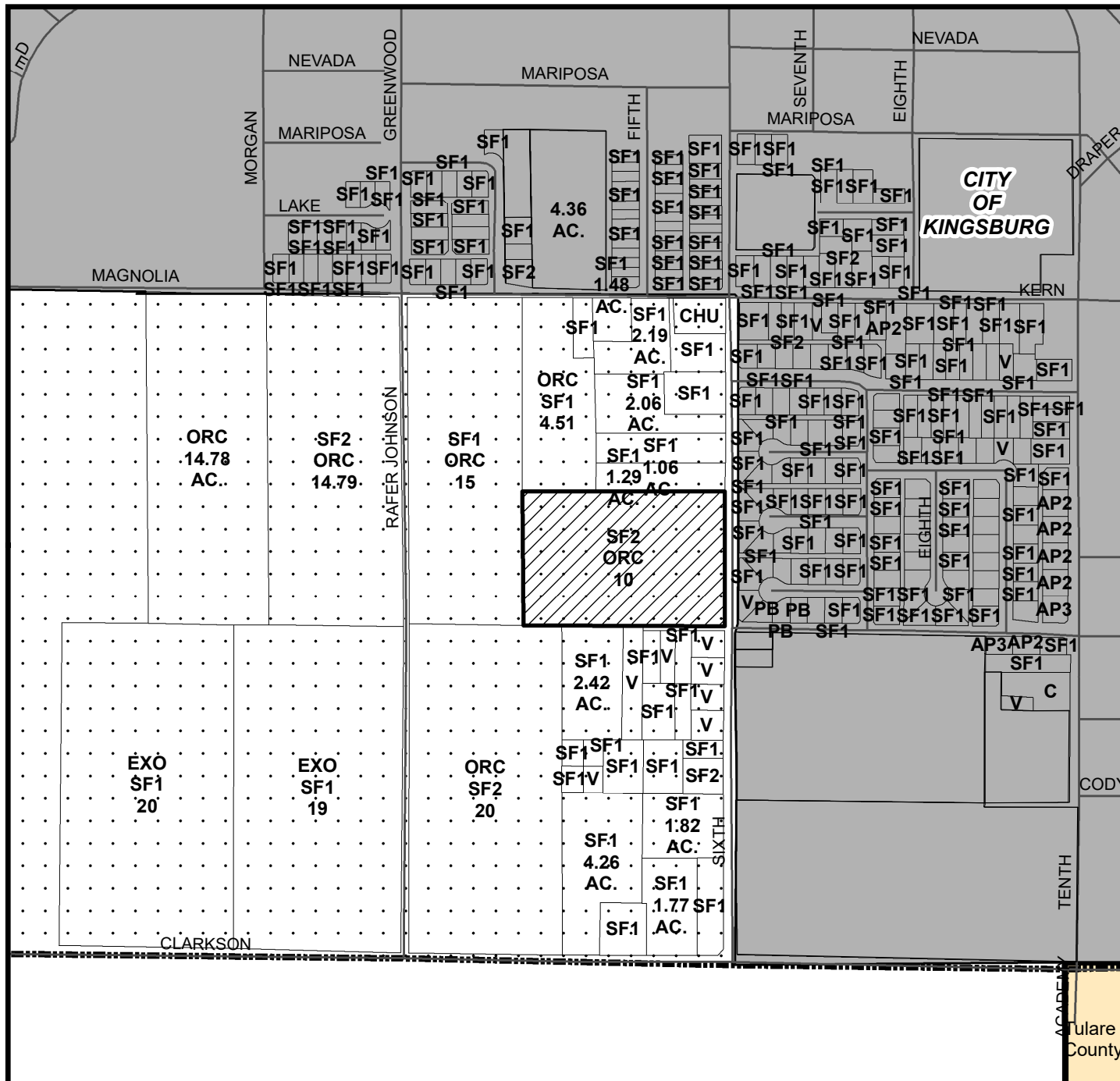

EXHIBIT 3





EXISTING LAND USE MAP

VA 4125



LEGEND	
AP1	- APARTMENT
C	- COMMERCIAL
CHU	- CHURCH
EXO	- EXOTIC CROP
ORC	- ORCHARD
PONDING BASIN	
SF#	- SINGLE FAMILY RESIDENCE
V	- VACANT

LEGEND:

-  Subject Property
-  City of Kingsburg
-  City Sphere of Influence
-  Tulare County

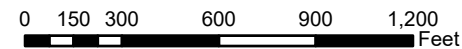

Department of Public Works and Planning
Development Services Division

EXHIBIT 5
 Project Location: 863 6th Avenue Drive, Kingsburg, CA 93631
 Lot proposal for APN: 395-030-11

Total Current Gross Acreage 10.0 acres

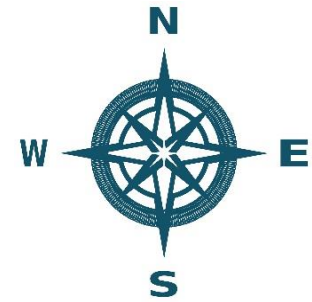
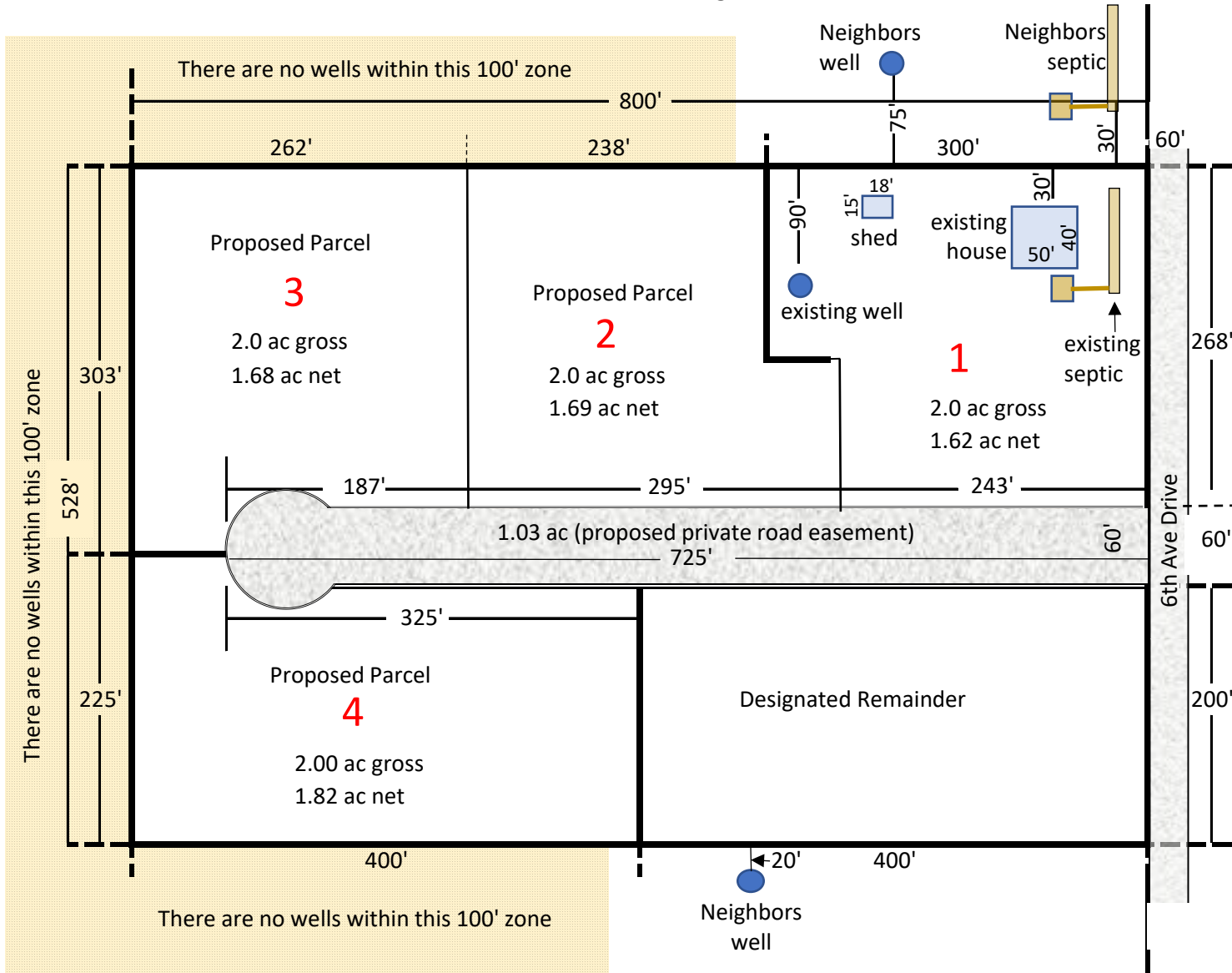

1 cm = 50 ft

Gross Current Parcel
 Dimensions are:
 825' x 528'

S/E Crnr looking West



S/W crnr looking North



Middle of east side looking North

863 6th Ave



N/E crnr looking South

863 6th Ave

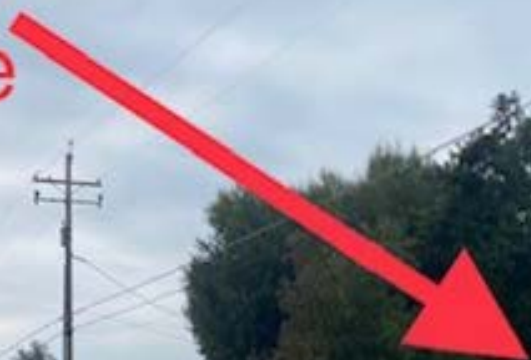

East side looking South

863 6th Ave



N/W crnr looking East



N/E crnr looking South



S/W crnr
looking East



S/W crnr looking North



EXHIBIT 7

Operational Statement

for

863 6th Avenue Drive
Kingsburg, CA 93631

APN: 395-030-11

Submitted: 09/06/2019

Owners:

David R. King ph: 559-246-0351 email: david@drdavidking.com

Carrie A.King ph: 559-246-0564 email: carrie@drdavidking.com

Acting Agent:

Lawrence A. King ph: 559-307-1165 email: kingfarms@msn.com

Project Description:

This lot split proposal is being submitted by David and Carrie King and pertains to 10 acres of property located at 863 6th Ave Drive in Kingsburg, CA 93631. It is APN: 395-030-11 and is zoned **AL** with a current use of almond orchard.

We are requesting authorization to divide the current 10 acre parcel into four additional parcels of approximately 1.80 acres each in size for the purpose of micro-farming and agriculture use. There will be approximately 0.80 acre devoted to a roadway within the bounds of the current parcel. The space situated in the southwestern corner labeled #5 (see attached map) would be left as the remaining undeveloped parcel.

Due to the close proximity to the City of Kingsburg, it is getting increasingly difficult to operate the farm with concerns of dust, noise and chemicals. Dividing the property into smaller units would provide for more manageable ranching activities on a micro-farm level as well as allow us to conform to our neighbors to the north and south of us. *Currently, we are the only sizable farming operation in our zoning classification.*

6th Avenue Drive runs along the eastern boundary of the property. We propose creating a private asphalt roadway running east-west approximately in the middle of the current parcel for access to each of the new lots. An annual fee would be due to provide for maintenance of the roadway. In addition, we may also build a boundary along the southern border of the current lot for better privacy.

Currently, there is a single well on the property. We would anticipate a significant decrease in total water usage for the 10 acres from the current water-intensive almond orchard. In addition, the City of Kingsburg has given permission to connect with city water and sewage for the current residence and tacit permission for any of the new parcels who choose to do so.

Our proposal does not include plans for additional buildings for commercial purposes. Each lot will be case by case with the county as to use and building construction.

Attached is a map of the proposed division.

Variance Application Findings

For David and Carrie King

Lot Proposal APN: 395-030-11

- 1. *There are exceptional or extraordinary circumstances or conditions applicable to the property involved which do not apply generally to other properties in the vicinity having the identical zoning classification.***

The subject property is zoned "AL – Agriculture Limited" and is nearly in the middle of the country block. There are 10 AL zoned parcels to the north and 24 AL zoned parcels south of the subject parcel. It is more than twice as large as the next sized parcel. The average size of the other 34 AL parcels is **0.93** acres. Large-scale farming is difficult due to the proximity of the neighbors including the medium density housing all along the eastern boundary of 6th Ave Drive.

Allowing the subject parcel to be divided into parcels equal to 2.0 gross acres each would allow the creation of "Gentleman Farms" and apply a consistent parcel size that is more cohesive to the identical zoning classification of neighboring parcels. It will aid in the maintaining, breeding and raising of poultry, rabbits, bovine and equine animals for FFA, 4-H and similar organizations.

- 2. *Such variance is necessary for the preservation and enjoyment of a substantial property right of the applicant, which right is possessed by other property owners under like conditions in the vicinity having the identical zoning classification.***

The subject property is currently unduly burdened because it's only able to function as a large farming operation. The variance is necessary due to the practical difficulties in large scale farming next to residential zoning as well as the surrounding county home sites. Granting the variance would do substantial justice to this property. It would eliminate the undue hardship of not being similar in size to the other "AL" zoned neighboring properties and it would allow this property to be reasonably used in a manner consistent with the existing zoning.

- 3. *The granting of the variance will not be materially detrimental to the public welfare or injurious to property and improvement in the vicinity in which the property is located.***

The proposed variance will reflect the current land division trend in the area and can meet any future County improvements. The water table depth is at 42 feet and has sandy loam soil which is adequate for providing separation of both sewer and water services for the proposed lot sizes. A road easement to the parcels consisting of a 60-foot-wide private, non-exclusive, easement may connect in the future to 6th Ave Drive. The variance will not be detrimental to the public welfare or injurious to property improvements in the vicinity.

Note the sizes of the surrounding parcels within 300 feet of subject parcel:

Northside Parcels Zoned "AL"

- 1) 1.29 acres
- 2) 1.06 acres

- 3) 2.06 acres
- 4) 4.5 acres

Southside Parcels Zoned "AL"

- 1) 0.3 acres
- 2) 0.3 acres
- 3) 0.3 acres
- 4) 0.3 acres
- 5) 0.3 acres
- 6) 0.3 acres
- 7) 0.3 acres
- 8) 0.6 acres
- 9) 0.6 acres
- 10) 2.42 acres

Eastern Bordering Property – City of Kingsburg Residential

- 1) 23 city lots

Westside Parcel Zoned "AE"

- 1) 15.0 acres

4. The granting of such variance will not be contrary to the objectives of the Fresno County General Plan

The variance will not be contrary to the objects of the Fresno County General Plan. Notwithstanding the difficulties for a large farming operation mentioned in the operational statement it will, in fact, become more compliant to the "Agricultural Limited" zoning to by creating "Gentleman Farmer" sized parcels. It will aid in the maintaining, breeding and raising of poultry, rabbits, bovine and equine animals for FFA, 4-H and similar organizations.

The water table is at 42 feet and is sustainable and adequate for each proposed parcel. The parcels have enough area for individual on-site sewage disposal systems due to the soil and other characteristics that would allow such disposal facilities without threatening surface or ground water quality.

The subject parcel is not in the Williamson Act.

APPROVED DIRECTOR REVIEWS WITHIN A QUARTER MILE RADIUS

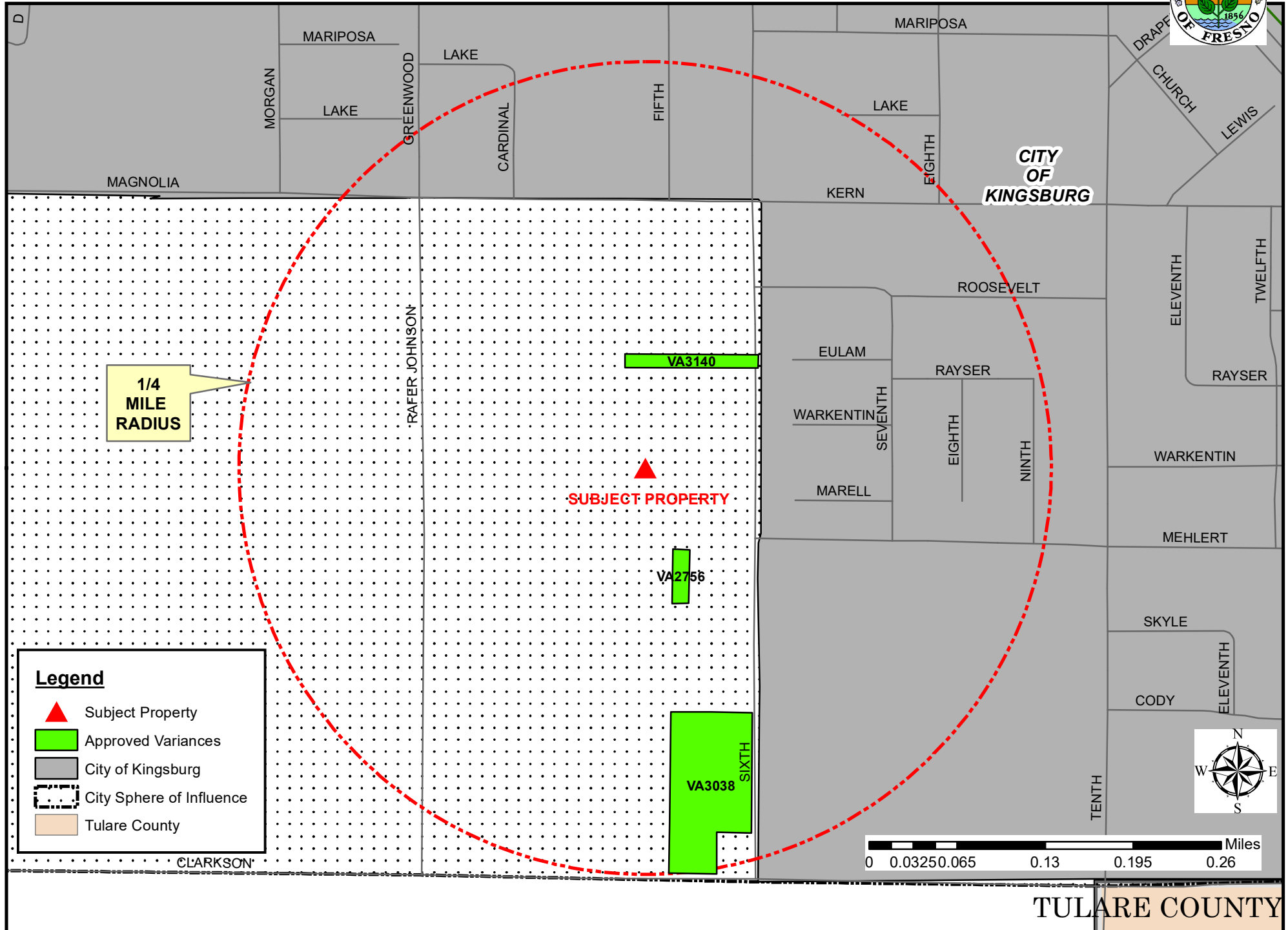

1/4 MILE RADIUS





SUBJECT PROPERTY

VA3140

VA2756

VA3038

Legend

-  Subject Property
-  Approved Variances
-  City of Kingsburg
-  City Sphere of Influence
-  Tulare County

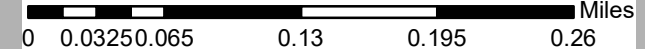

TULARE COUNTY

EXHIBIT 1

**Mitigation Monitoring and Reporting Program
 Variance Application No. 4125 & Environmental Review No. 8163
 (Including Conditions of Approval and Project Notes)**

Conditions of Approval	
1.	Development shall be in accordance with the site plan as approved by the Planning Commission.
2.	If the variance waiving road frontage is approved, all roads and/or access easements must conform to Fresno County Road standards.

Notes	
The following Notes reference mandatory requirements of Fresno County or other Agencies and are provided as information to the project Applicant.	
1.	An encroachment permit is needed from the Road Maintenance and Operations Division for any work done within the road right-of-way of County of Fresno.
2.	Future construction projects have the potential to expose nearby residents to elevated noise levels. Consideration should be given to the County of Fresno noise ordinance and the City of Kingsburg municipal codes.
3.	At such time the applicant or property owner(s) decides to construct a new water well, the water well contractor selected by the applicant will be required to apply for and obtain a Permit to Construct a Water Well from the Fresno County Department of Community Health, Environmental Health Division. Please be advised that only those persons with a valid C-57 contractor's license may construct wells. For more information, contact the Water Surveillance Program at (559) 600-3357.
4.	As a measure to protect ground water, all water wells and/or septic systems that exist or have been abandoned within the project area should be properly destroyed by an appropriately licensed contractor.
5.	Should any underground storage tank(s) be found, the applicant shall apply for and secure an Underground Storage Tank Removal Permit from the Fresno County Department of Public Health, Environmental Health Division. Contact the Fresno County Hazmat Compliance Program at (559) 600-3271 for more information.
6.	All new sewage disposal systems that are proposed, shall be installed under permit and inspection by the Department of Public Works and Planning Building and Safety Section. Contact Department of Public Works and Planning at (559) 600- 4540 for more information.
7.	According to FEMA FIRM Panel 2675H, the parcel is not subject to flooding from the 100- year storm
8.	The subject property is within the City of Kingsburg SOI (Sphere of Influence). Any future off-site improvements and driveway placement relative to the property line should be consulted with the City regarding their requirements.
9.	Any existing or future access driveway should be set back a minimum of 10 feet from the property line.

Notes	
10.	Any existing or future entrance gate should be set back a minimum of 20 feet from the road right-of-way line or the length of the longest truck entering the site and shall not swing outward.
11.	A 10 foot x 10 foot corner cut-off should be improved for sight distance purposes at any future or existing driveway accessing Sixth Avenue Drive if not already present.
12.	Any future work done within the County road right-of-way to construct a new driveway or improve an existing driveway will require an Encroachment Permit from the Road Maintenance and Operations Division.
13.	If the variance is approved, a parcel map application will have to be filed with Fresno County to affect the property division. Furthermore, if there is no legal access provided to any proposed parcel without public frontage access, a covenant is required, whereby the Subdivider agrees to grant a 60' wide access easement to each parcel as it is created. A Registered Civil Engineer shall certify the access easements are improved to a condition to meet the needs of the users. And any future grading, including onsite grading, will require either an engineered grading and drainage plan, road improvement plan, permit, or voucher.
14.	Any new development of less than two acres or secondary dwelling will require a nitrogen loading analysis by a qualified professional, demonstrating to the Department of Public Works and Planning (Department) that the regional characteristics are such that an exception to the septic system density limit can be accommodated. The Department will refer any analysis to the Regional Water Quality Control Board, Central Valley Region for their concurrence and input.
15.	It is the recommendation of the County Surveyor's Office that this application be denied, unless 1) the limits of the Subdivision and the Designated Remainder can be clearly shown on the application, and 2) any improvements (access easement/roadway cul-de-sac) for the purposes of the Subdivision lie wholly within the limits of the Subdivision.

LOCATION MAP

VA 4125

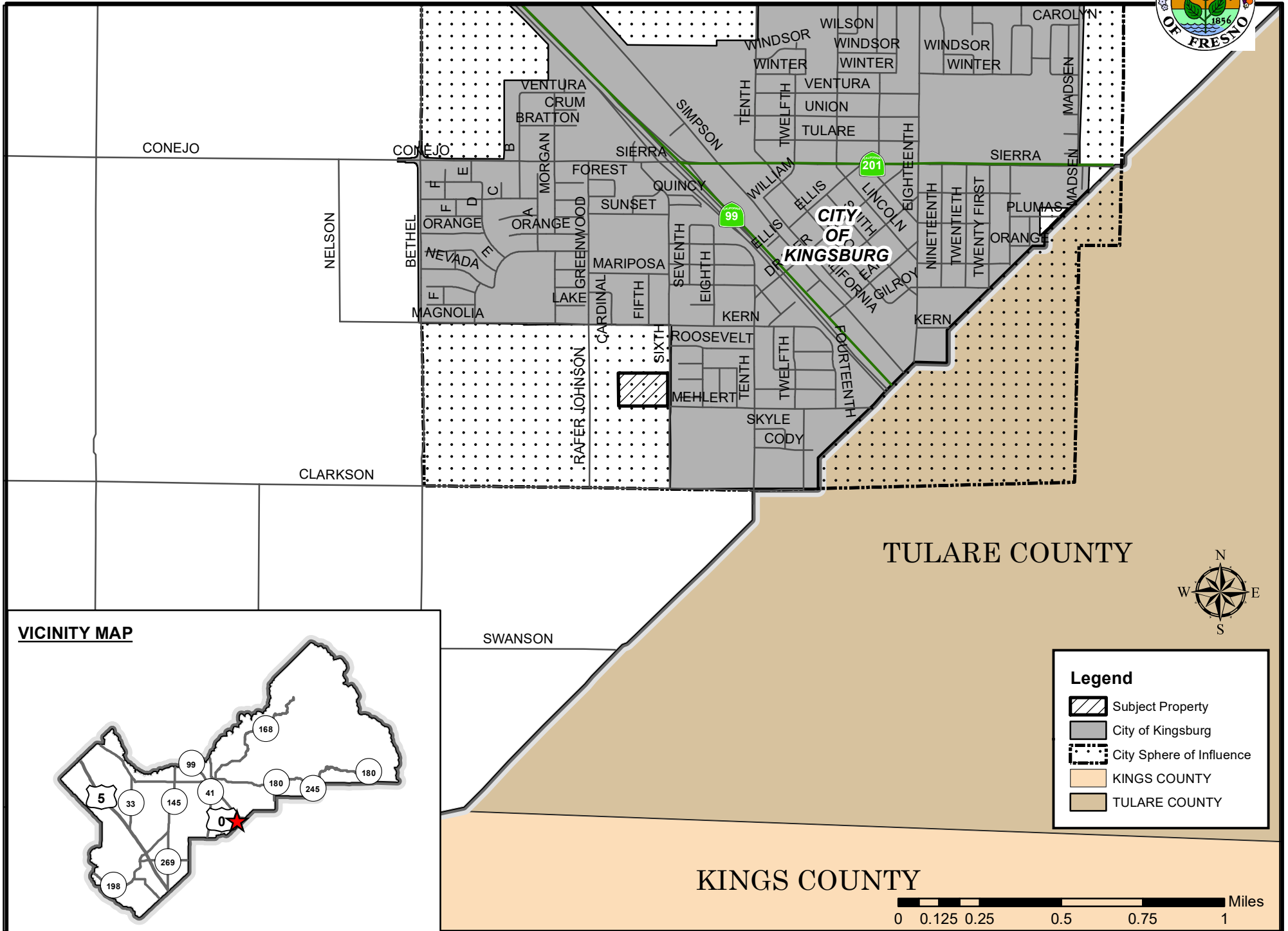
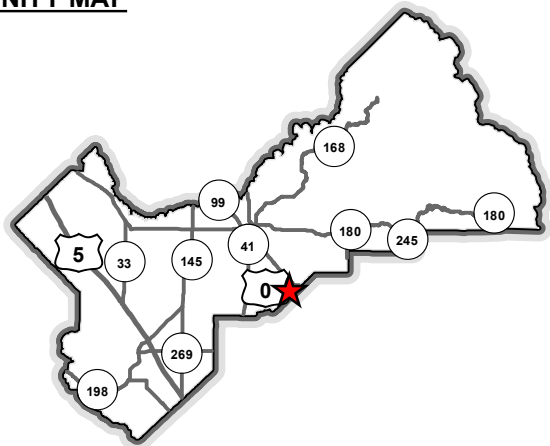

EXHIBIT 2





VICINITY MAP



TULARE COUNTY



Legend

-  Subject Property
-  City of Kingsburg
-  City Sphere of Influence
-  KINGS COUNTY
-  TULARE COUNTY

KINGS COUNTY

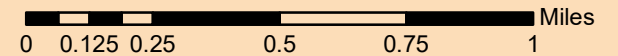

EXHIBIT 3
EXISTING ZONING MAP

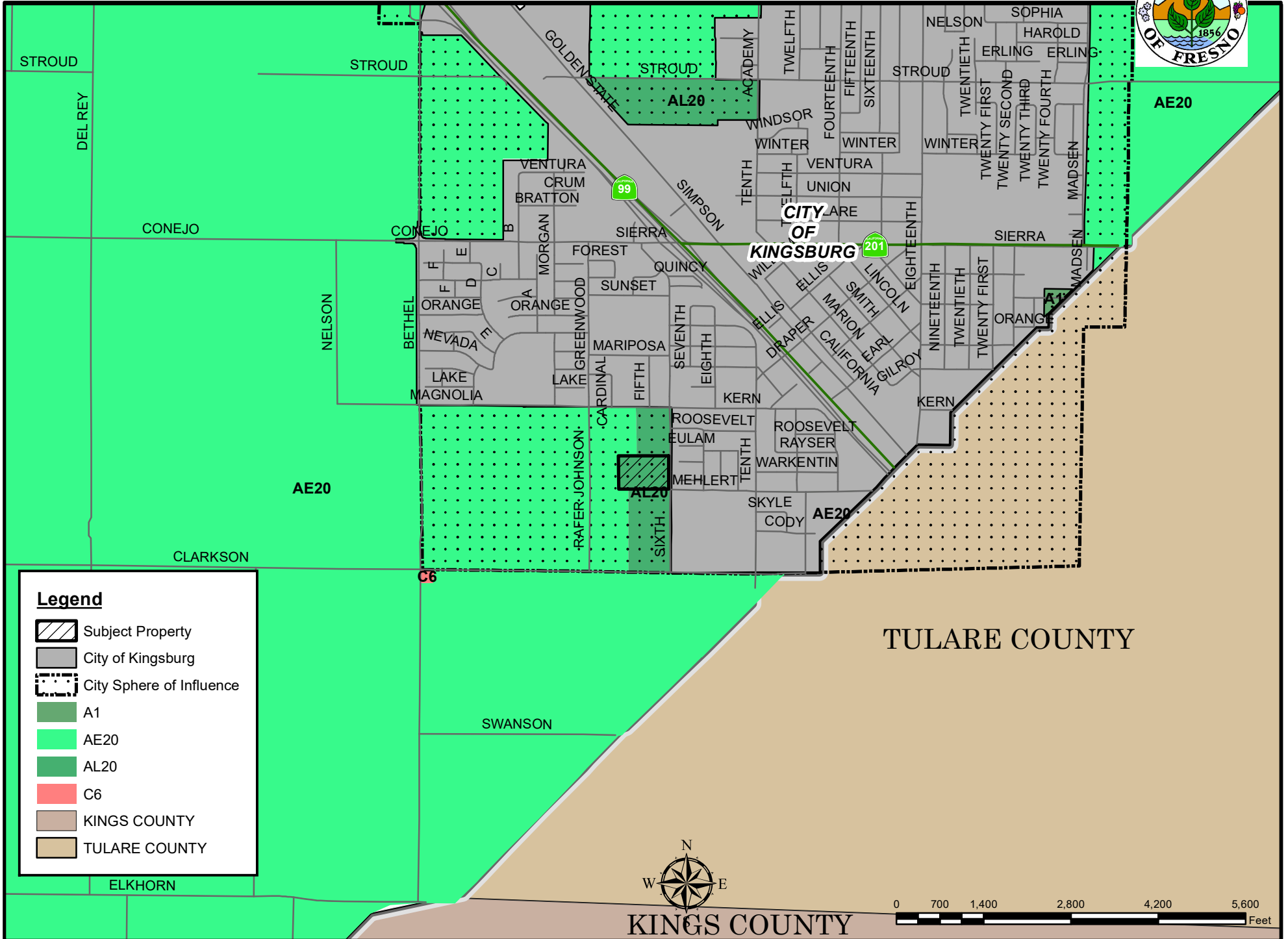
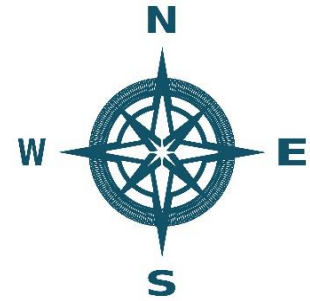
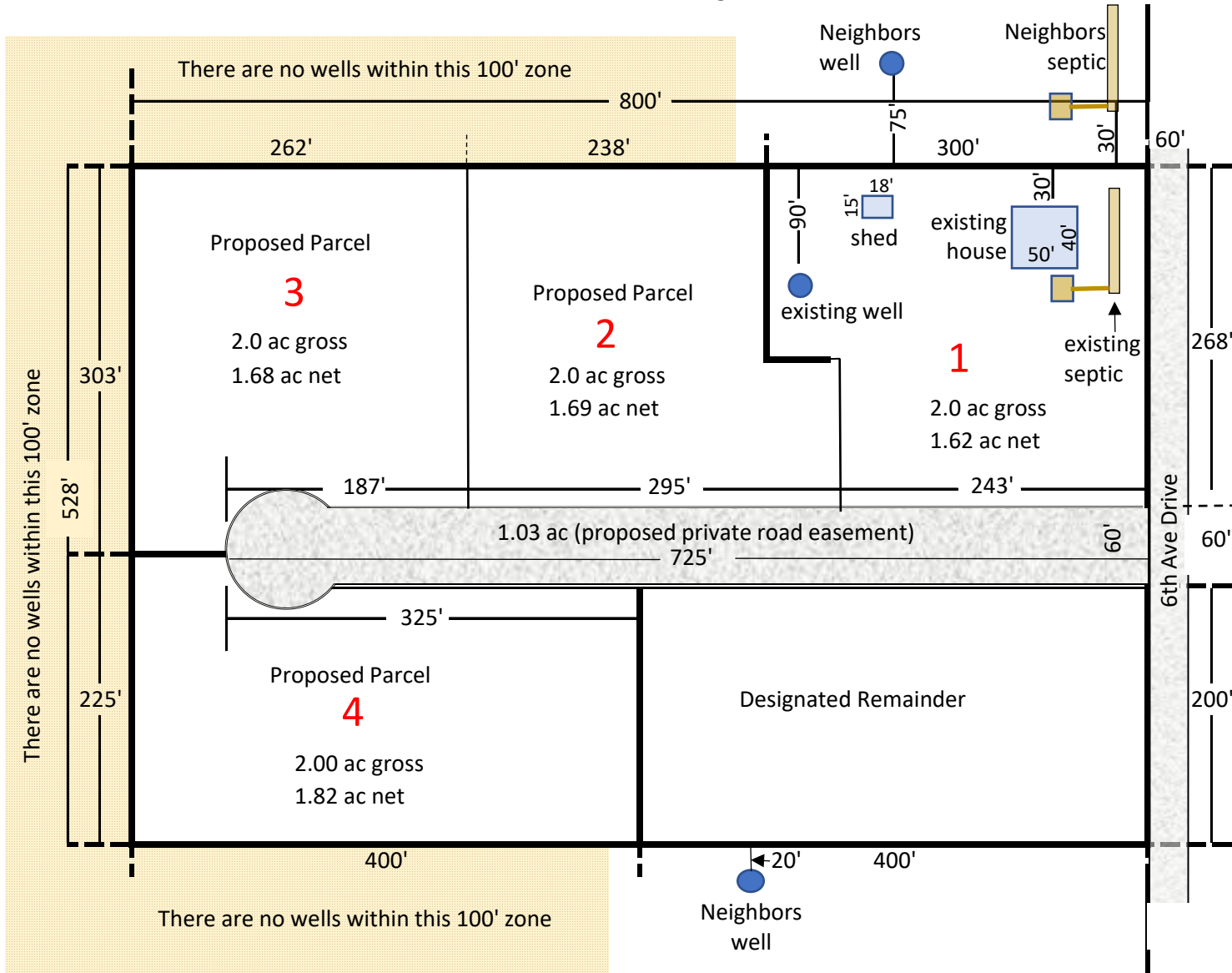

EXHIBIT 3

EXHIBIT 5
 Project Location: 863 6th Avenue Drive, Kingsburg, CA 93631
 Lot proposal for APN: 395-030-11

Total Current Gross Acreage 10.0 acres



1 cm = 50 ft

Gross Current Parcel
 Dimensions are:
 825' x 528'

S/E Crnr looking West



S/W crnr looking North



Middle of east side looking North

863 6th Ave



N/E crnr looking South

863 6th Ave



East side looking South

863 6th Ave



N/W crnr looking East



N/E crnr looking South



S/W crnr
looking East



S/W crnr looking North



EXHIBIT 7

Operational Statement

for

863 6th Avenue Drive
Kingsburg, CA 93631

APN: 395-030-11

Submitted: 09/06/2019

Owners:

David R. King ph: 559-246-0351 email: david@drdavidking.com

Carrie A.King ph: 559-246-0564 email: carrie@drdavidking.com

Acting Agent:

Lawrence A. King ph: 559-307-1165 email: kingfarms@msn.com

Project Description:

This lot split proposal is being submitted by David and Carrie King and pertains to 10 acres of property located at 863 6th Ave Drive in Kingsburg, CA 93631. It is APN: 395-030-11 and is zoned **AL** with a current use of almond orchard.

We are requesting authorization to divide the current 10 acre parcel into four additional parcels of approximately 1.80 acres each in size for the purpose of micro-farming and agriculture use. There will be approximately 0.80 acre devoted to a roadway within the bounds of the current parcel. The space situated in the southwestern corner labeled #5 (see attached map) would be left as the remaining undeveloped parcel.

Due to the close proximity to the City of Kingsburg, it is getting increasingly difficult to operate the farm with concerns of dust, noise and chemicals. Dividing the property into smaller units would provide for more manageable ranching activities on a micro-farm level as well as allow us to conform to our neighbors to the north and south of us. *Currently, we are the only sizable farming operation in our zoning classification.*

6th Avenue Drive runs along the eastern boundary of the property. We propose creating a private asphalt roadway running east-west approximately in the middle of the current parcel for access to each of the new lots. An annual fee would be due to provide for maintenance of the roadway. In addition, we may also build a boundary along the southern border of the current lot for better privacy.

Currently, there is a single well on the property. We would anticipate a significant decrease in total water usage for the 10 acres from the current water-intensive almond orchard. In addition, the City of Kingsburg has given permission to connect with city water and sewage for the current residence and tacit permission for any of the new parcels who choose to do so.

Our proposal does not include plans for additional buildings for commercial purposes. Each lot will be case by case with the county as to use and building construction.

Attached is a map of the proposed division.

Variance Application Findings

For David and Carrie King

Lot Proposal APN: 395-030-11

- 1. There are exceptional or extraordinary circumstances or conditions applicable to the property involved which do not apply generally to other properties in the vicinity having the identical zoning classification.***

The subject property is zoned "AL – Agriculture Limited" and is nearly in the middle of the country block. There are 10 AL zoned parcels to the north and 24 AL zoned parcels south of the subject parcel. It is more than twice as large as the next sized parcel. The average size of the other 34 AL parcels is **0.93** acres. Large-scale farming is difficult due to the proximity of the neighbors including the medium density housing all along the eastern boundary of 6th Ave Drive.

Allowing the subject parcel to be divided into parcels equal to 2.0 gross acres each would allow the creation of "Gentleman Farms" and apply a consistent parcel size that is more cohesive to the identical zoning classification of neighboring parcels. It will aid in the maintaining, breeding and raising of poultry, rabbits, bovine and equine animals for FFA, 4-H and similar organizations.

- 2. Such variance is necessary for the preservation and enjoyment of a substantial property right of the applicant, which right is possessed by other property owners under like conditions in the vicinity having the identical zoning classification.***

The subject property is currently unduly burdened because it's only able to function as a large farming operation. The variance is necessary due to the practical difficulties in large scale farming next to residential zoning as well as the surrounding county home sites. Granting the variance would do substantial justice to this property. It would eliminate the undue hardship of not being similar in size to the other "AL" zoned neighboring properties and it would allow this property to be reasonably used in a manner consistent with the existing zoning.

- 3. The granting of the variance will not be materially detrimental to the public welfare or injurious to property and improvement in the vicinity in which the property is located.***

The proposed variance will reflect the current land division trend in the area and can meet any future County improvements. The water table depth is at 42 feet and has sandy loam soil which is adequate for providing separation of both sewer and water services for the proposed lot sizes. A road easement to the parcels consisting of a 60-foot-wide private, non-exclusive, easement may connect in the future to 6th Ave Drive. The variance will not be detrimental to the public welfare or injurious to property improvements in the vicinity.

Note the sizes of the surrounding parcels within 300 feet of subject parcel:

Northside Parcels Zoned "AL"

- 1) 1.29 acres
- 2) 1.06 acres

- 3) 2.06 acres
- 4) 4.5 acres

Southside Parcels Zoned "AL"

- 1) 0.3 acres
- 2) 0.3 acres
- 3) 0.3 acres
- 4) 0.3 acres
- 5) 0.3 acres
- 6) 0.3 acres
- 7) 0.3 acres
- 8) 0.6 acres
- 9) 0.6 acres
- 10) 2.42 acres

Eastern Bordering Property – City of Kingsburg Residential

- 1) 23 city lots

Westside Parcel Zoned "AE"

- 1) 15.0 acres

4. The granting of such variance will not be contrary to the objectives of the Fresno County General Plan

The variance will not be contrary to the objects of the Fresno County General Plan. Notwithstanding the difficulties for a large farming operation mentioned in the operational statement it will, in fact, become more compliant to the "Agricultural Limited" zoning to by creating "Gentleman Farmer" sized parcels. It will aid in the maintaining, breeding and raising of poultry, rabbits, bovine and equine animals for FFA, 4-H and similar organizations.

The water table is at 42 feet and is sustainable and adequate for each proposed parcel. The parcels have enough area for individual on-site sewage disposal systems due to the soil and other characteristics that would allow such disposal facilities without threatening surface or ground water quality.

The subject parcel is not in the Williamson Act.

EXHIBIT 9 APPROVED DIRECTOR REVIEWS WITHIN A QUARTER MILE RADIUS

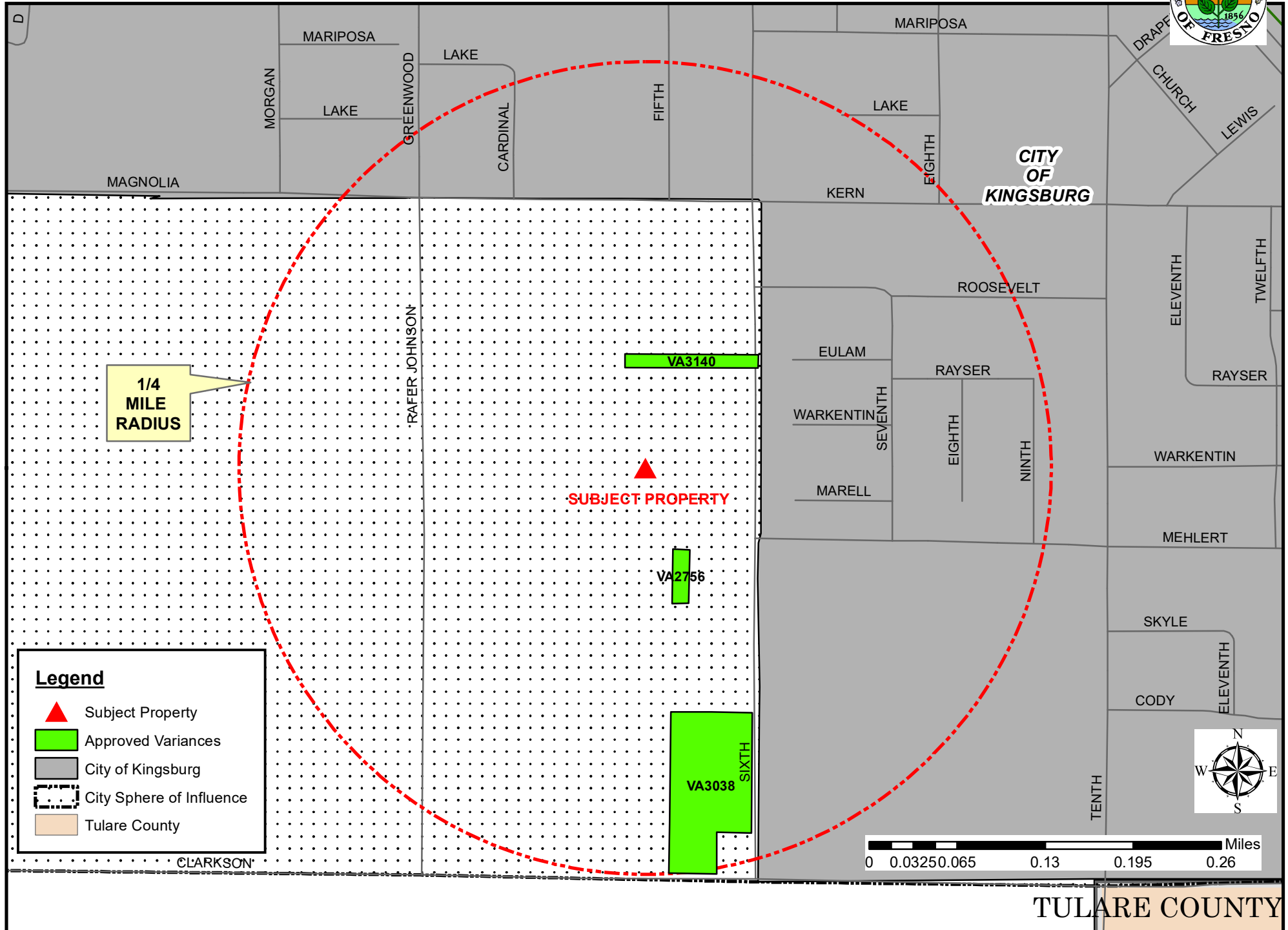

EXHIBIT 9

RECEIVED
MAY 20 2022

CLERK, BOARD OF SUPERVISORS



For Office Use Only	
Date received:	5-20-22
Copied to:	W. Kettler, C. Motta, D. Randa
Date copy sent:	5-24-22 A. Samari
Hearing set for:	

NOTICE OF APPEAL OF PLANNING COMMISSION DECISION

Date: 05/19/22

Appeal Fee: \$508 – Due when filing appeal

APPELLANT FILL IN BELOW THIS LINE, THIS SIDE ONLY – PLEASE PRINT OR TYPE

Project Site Address

863	6th Ave Drive	Kingsburg	93631	395-030-11
Number	Street	City	Zip	Assessor's Parcel Number

Appellant's Information

Name: Larry King

Mailing Address: 6296 E Mt View Ave
Selma CA 93662

Telephone: 559-307-1165

Applicant's Information check if same as Appellant)

Name: David King

Mailing Address: 9043 N McAfee
Camas WA 98607

Telephone: 559-246-0351

Subject of Appeal

I wish to appeal the Planning Commission's decision to Approve Deny

Variance Application No.* 4125

Conditional Use Permit No. _____

Director Review and Approval Application No. _____

Tentative Tract Application No. _____

Amendment Application No. _____

Amendment to Text Application No. _____

Other: _____

Date of Planning Commission Action 5/19/22

Reason(s) for Appeal (Attach additional sheets if necessary)

I am appealing the 5 to 1 vote on variance application #4125. In order to get a County Supervisor ruling with a more current view on the property use for the current AL (Ag Limited) zoning. I feel that the commission was held to a 1958 ordinance, in which members didn't feel comfortable looking at the bigger picture. I would like the opportunity to present this to the County Supervisors. I am asking to allow my property to be used in the same manor as my neighbors in the same zoning.

Appellant's Signature

* Fresno County Zoning Ordinance § 877(c) requires that any appellant, other than the applicant, County Department Director, or Board of Supervisors member, must be a property owner within a certain distance from the Variance Application property. The Department of Public Works and Planning will verify that the ordinance requirements are met. If the requirements are not met, the appeal fee will be returned and no date for appeal hearing before the Board of Supervisors will be set.

Please return completed form to Clerk of the Board, 2281 Tulare Street, Room 301, Fresno, CA 93721.

ATTACHMENT D

**Mitigation Monitoring and Reporting Program
Variance Application No. 4125 & Environmental Review No. 8163
(Including Conditions of Approval and Project Notes)**

Conditions of Approval	
1.	Development shall be in accordance with the site plan as approved by the Planning Commission.
2.	If the variance waiving road frontage is approved, all roads and/or access easements must conform to Fresno County Road standards.

Notes	
The following Notes reference mandatory requirements of Fresno County or other Agencies and are provided as information to the project Applicant.	
1.	An encroachment permit is needed from the Road Maintenance and Operations Division for any work done within the road right-of-way of County of Fresno.
2.	Future construction projects have the potential to expose nearby residents to elevated noise levels. Consideration should be given to the County of Fresno noise ordinance and the City of Kingsburg municipal codes.
3.	At such time the applicant or property owner(s) decides to construct a new water well, the water well contractor selected by the applicant will be required to apply for and obtain a Permit to Construct a Water Well from the Fresno County Department of Community Health, Environmental Health Division. Please be advised that only those persons with a valid C-57 contractor's license may construct wells. For more information, contact the Water Surveillance Program at (559) 600-3357.
4.	As a measure to protect ground water, all water wells and/or septic systems that exist or have been abandoned within the project area should be properly destroyed by an appropriately licensed contractor.
5.	Should any underground storage tank(s) be found, the applicant shall apply for and secure an Underground Storage Tank Removal Permit from the Fresno County Department of Public Health, Environmental Health Division. Contact the Fresno County Hazmat Compliance Program at (559) 600-3271 for more information.
6.	All new sewage disposal systems that are proposed, shall be installed under permit and inspection by the Department of Public Works and Planning Building and Safety Section. Contact Department of Public Works and Planning at (559) 600- 4540 for more information.
7.	According to FEMA FIRM Panel 2675H, the parcel is not subject to flooding from the 100- year storm
8.	The subject property is within the City of Kingsburg SOI (Sphere of Influence). Any future off-site improvements and driveway placement relative to the property line should be consulted with the City regarding their requirements.
9.	Any existing or future access driveway should be set back a minimum of 10 feet from the property line.

Notes	
10.	Any existing or future entrance gate should be set back a minimum of 20 feet from the road right-of-way line or the length of the longest truck entering the site and shall not swing outward.
11.	A 10 foot x 10 foot corner cut-off should be improved for sight distance purposes at any future or existing driveway accessing Sixth Avenue Drive if not already present.
12.	Any future work done within the County road right-of-way to construct a new driveway or improve an existing driveway will require an Encroachment Permit from the Road Maintenance and Operations Division.
13.	If the variance is approved, a parcel map application will have to be filed with Fresno County to affect the property division. Furthermore, if there is no legal access provided to any proposed parcel without public frontage access, a covenant is required, whereby the Subdivider agrees to grant a 60' wide access easement to each parcel as it is created. A Registered Civil Engineer shall certify the access easements are improved to a condition to meet the needs of the users. And any future grading, including onsite grading, will require either an engineered grading and drainage plan, road improvement plan, permit, or voucher.
14.	Any new development of less than two acres or secondary dwelling will require a nitrogen loading analysis by a qualified professional, demonstrating to the Department of Public Works and Planning (Department) that the regional characteristics are such that an exception to the septic system density limit can be accommodated. The Department will refer any analysis to the Regional Water Quality Control Board, Central Valley Region for their concurrence and input.
15.	It is the recommendation of the County Surveyor's Office that this application be denied, unless 1) the limits of the Subdivision and the Designated Remainder can be clearly shown on the application, and 2) any improvements (access easement/roadway cul-de-sac) for the purposes of the Subdivision lie wholly within the limits of the Subdivision.